

Φωτιστικά με την δύναμη της ηλιακής ενέργειας



- Η πρωτοπόρος τεχνολογία των φωτιστικών σωμάτων του οίκου AMKO μας δίνει τη δυνατότητα να έχουμε μεγάλη απόδοση χαμηλό κόστος ενέργειας και μεγάλη διάρκεια ζωής των λαμπτήρων.

XELON
Energieia



GREEN LIGHTING - Environmentally Friendly

Installing SOLARA Induction lamp can significantly reduce the amount of waste of used light tubes and bulbs (inclusive of packaging and shipping), and save on energy costs. Using one 400W SOLARA lamp is the equivalent of the following substitution:

Green Lighting



Mercury Vapor x 20



T5 FL x 108



Metal Halide x 25



T8 FL x 500



High Power U CFL x 50



Incandescent x 1067

SOLARA x 1

ENERGEIA
XELON



Τύποι φωτιστικών εσωτερικών χώρων από 100w έως 400w

AMKO



AMKO

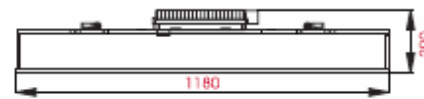

(mm)

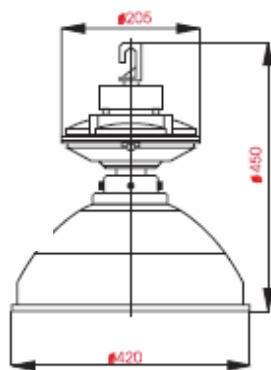

AF6-127

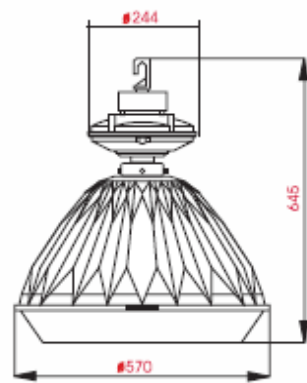

AF6-122
AF6-129

(mm)



XELON
Energeia



Τύποι φωτιστικών εξωτερικών χώρων από 100w έως 150w

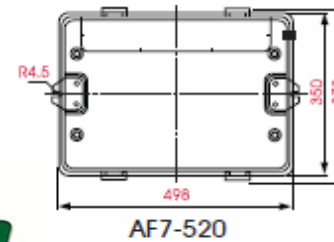
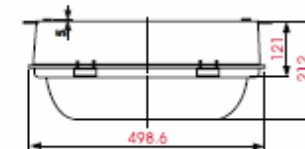
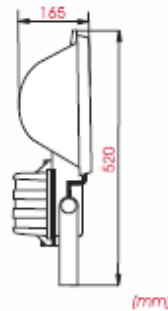
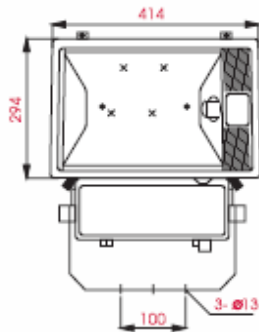

XELON
Energeia



Τύποι φωτιστικών δρόμων από 100w έως 250w



Roadway Luminaire



XELON
Energieia



• • • | Τύποι φωτιστικών κήπου
από 85w έως 100w

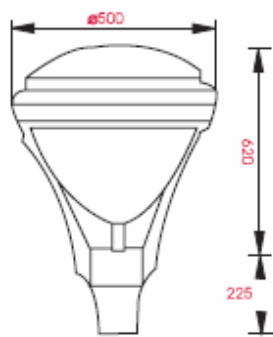

AF7-730

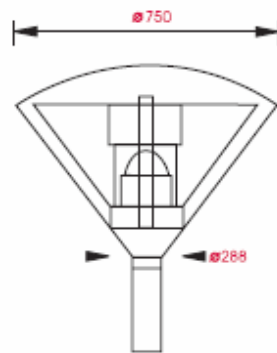

76 (mm)

AF7-740



AF7-904



AF7-750

XELON
Energeia